

# Cut costs, improve safety, increase efficiency: Layher AllroundScaffolding.

AllroundScaffolding®



Layher® 

More Possibilities. The Scaffolding System.

# Made by Layher.

## Supply and service worldwide.

### Market leader in Europe.

For more than 50 years now, Layher has been imparting crucial impulses to scaffolding construction and exerting a major influence on development with its ideas.

Layher provides intelligent problem solutions and products, convincing details, and unmatched economic efficiency.

Our scaffolding systems assure the success of our partners and are one of the reasons for the wide acceptance of Layher worldwide.

### For lasting partnership.

In Layher you have a reliable partner you can count on.

We can help you solve even the most difficult problems with economical solutions – we'd be happy to pass on to you the benefits of our 50 years of worldwide experience.

Your success is our aim.

### Your benefit.

Manufactured in Germany: We guarantee maximum quality, economic efficiency and service life;

DIN ISO 9001 certification, approvals from building supervisory authorities, plus thorough German TÜV inspections, are the guarantee of safety you can rely on;

Layher systems are versatile for a wide variety of applications, and can be combined with one another.

Series production with a high degree of automation ensures rapid product availability, and sales partners are ready to help and advise all over the world.

We serve you, wherever you are.

Aerial view  
of our production site  
in Germany.



# Fast.

# By unique connection technique.



# 64%

**64% Savings in Time\***

Superior system technology: wedge head connection for non-bolted, self-securing assembly; automatic right angles; a few basic components; material-saving logical assembly.

A comparison of **scaffolding structures** around a tank (Layher Allround scaffolding or tube/coupler scaffolding) proves **your advantage**:

Shorter assembly time, shorter dismantling time, lower labour costs; shorter "shut-down" periods, lower transport costs.

\* Figures in percent relate to the adjacent tank scaffolding.

**Tank scaffolding:**

Diameter: 9,6 m  
Height: 7,2 m  
Bay length: 2,57 m  
Bay height: 2,00 m



**Traditional scaffolding** **Layher Allround scaffolding**



With Layher Allround scaffolding, you can work much more profitably:

shorter assembly and dismantling times facilitate frequent use of equipment.

**Layher Allround scaffolding\*:**

Time: assembly 106 minutes  
Time: dismantling 71 minutes  
Total: **177 minutes**

**Tube/coupler scaffolding\*:**

Time: assembly 380 minutes  
Time: dismantling 115 minutes  
Total: **495 minutes**

# Strong. By ultimate bearing capacity.



# 28%

**28% Less Weight\***

Verified high load-bearing characteristics of the Allround joint: superior connection capacities and optimised transmission of forces reduce the material requirement to a minimum.

The comparison with **traditional scaffolding** proves the **advantage for you:**

A considerable reduction in material weight makes assembly faster and less fatiguing, therefore higher man performances are achieved; system technology also means a simple and logical assembly sequence, and permits the use of semi-skilled workers.

Traditional scaffolding



Layher Allround scaffolding



With Layher Allround scaffolding, you reduce the material weight to be moved whenever assembly and dismantling take place:

thanks to lighter material – in storage, and in transport to and from the site, and on the site itself.

**Layher Allround scaffolding\*:**

Total weight: 4430 kg  
Weight per m<sup>2</sup>: 20,4 kg

**Tube/coupler scaffolding\*:**

Total weight: 6185 kg  
Weight per m<sup>2</sup>: 28,5 kg



The Layher Allround System in steel with its highly functional components permits complex and very difficult scaffolding structures to be built.

The considerably lighter Allround scaffolding made of aluminium combines outstanding system technology with a substantial reduction in weight.

**Safe.**  
**By certified quality.**

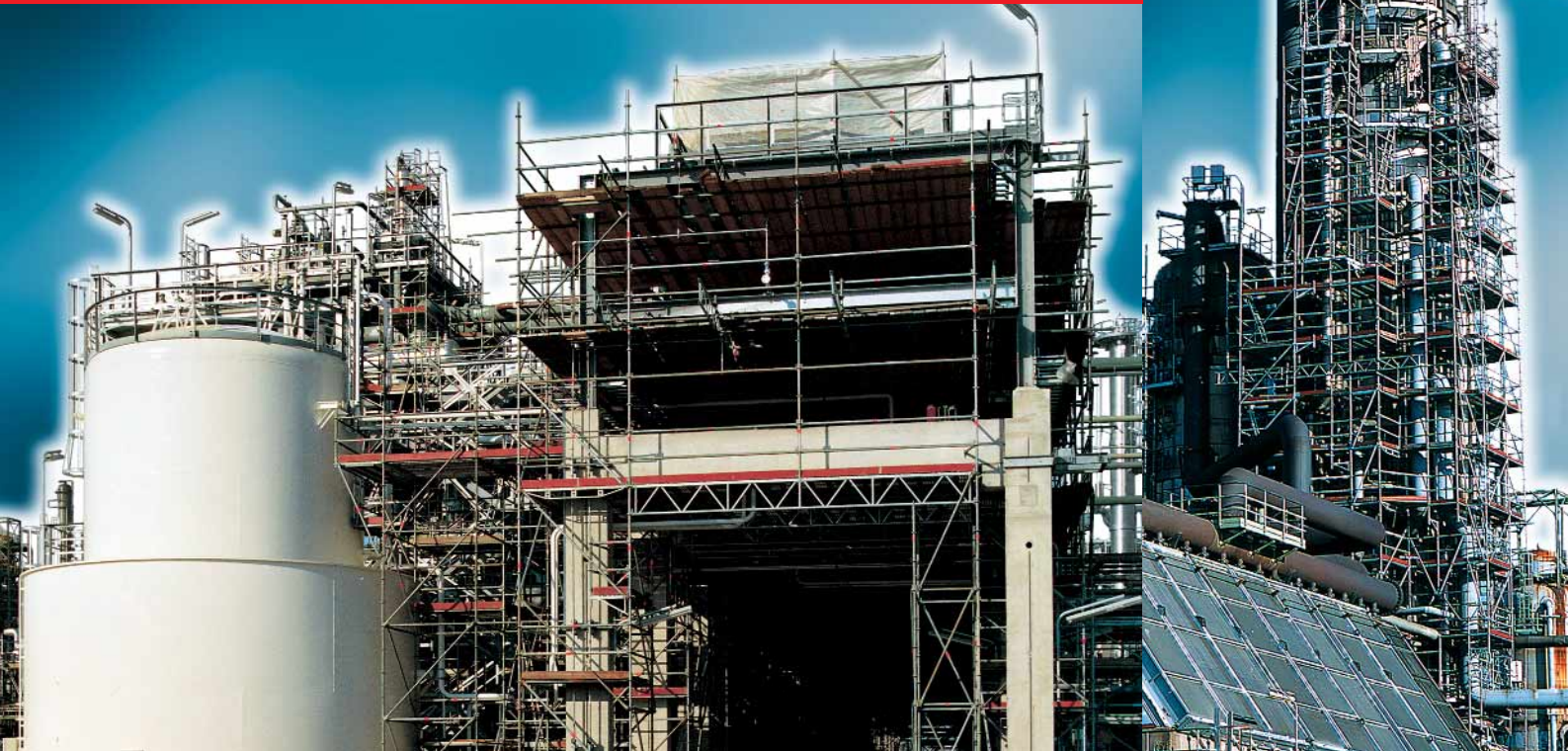

**60%** Less Maintenance  
and Losses

Superior Layher production technology: certified quality production, hot-dip-galvanised steel components; ingenious design for maintenance-free operation, unaffected by casual dirt.

The comparison with **traditional scaffolding material** proves the **advantage for you:**

No delays caused by imprecise fitting of individual components; sound financial returns thanks to the long life of the equipment; no costs due to material being cut to length or parts being lost, very low costs for maintenance and care; persistently high standard of your work.

Certification acc. to DIN ISO 9001/EN 29001

**TÜV**  
**CERT**  
Member of IIOC.

With Layher Allround scaffolding, you improve the quality of your service:

Certified production assures top quality and maximum safety; more ambitious projects can be accomplished with greater economic success and a safety standard to the highest level.

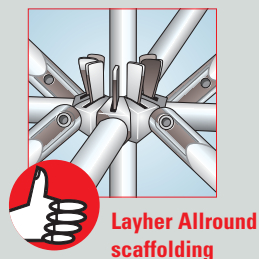

Traditional scaffolding:

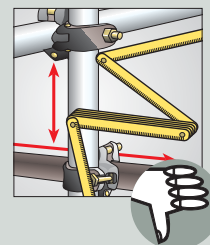
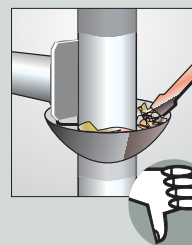
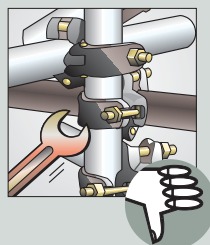

# Flexible. By unparalleled versatility.



# 100%

## 100% Flexibility

Clear system technology: the extensive range of components based on the modular principle allows every conceivable use for every requirement; optimum compatibility with other Layher systems.

The comparison provides proof of **your advantage**:

Intelligent system technology for flexibility in use; costs minimised by advance planning, logical and modular scaffolding assembly from the very start, without expensive reworking; extensive availability of materials at all times.

**Traditional scaffolding:**  
Maximum earnings

**Layher Allround scaffolding:**  
Maximum earnings



With Layher Allround equipment you achieve maximum returns:

thanks to system technology, you can work with highly flexible scaffolding equipment; maximum adaptation to existing structures or buildings.

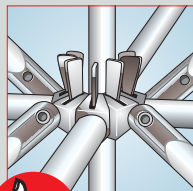

**Layher Allround scaffolding**

**Traditional scaffolding:**

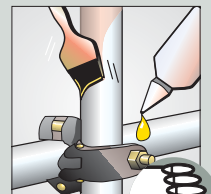
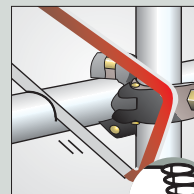
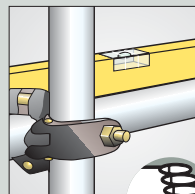

# Ingenious. Strong. Limitless.

## Layher Allround Scaffolding® – the "Original".

For more than 25 years, Layher Allround Scaffolding has been an investment in an optimised and complete system – in steel or aluminium.

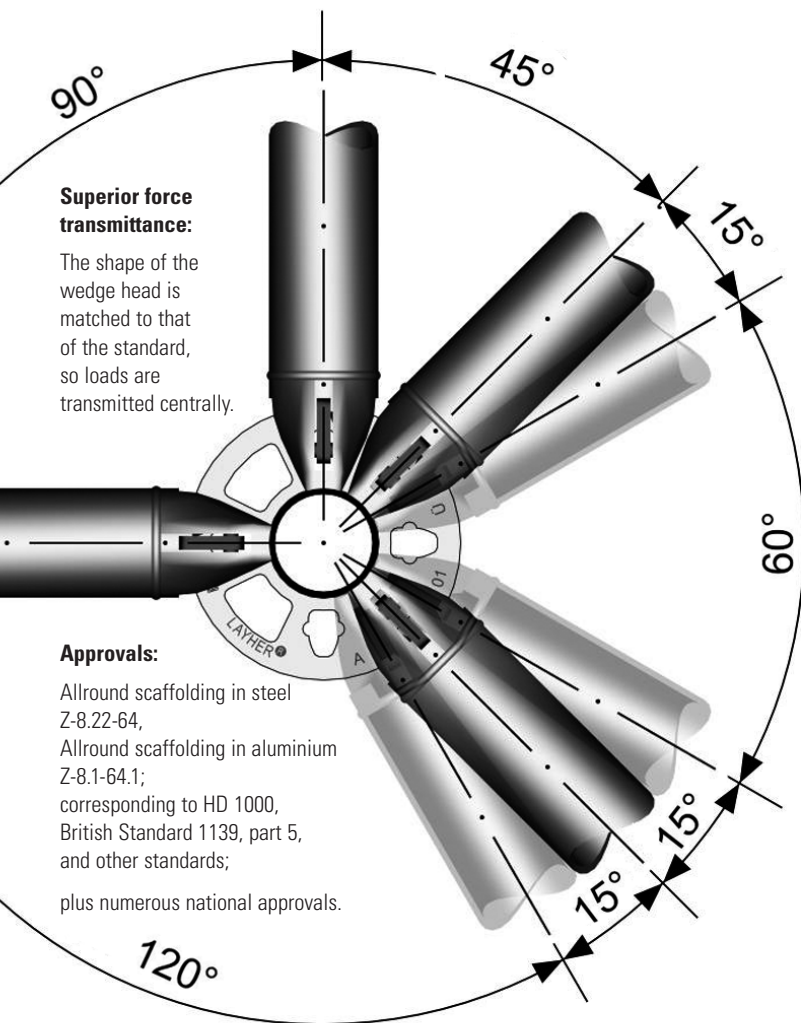

**Layher Allround Scaffolding permits optimum adaptation to the respective local problem:**

**A few basic components – standard, ledger, diagonal brace, deck – form the basis for almost limitless uses, and there are many additional parts for special solutions within the system;**

**all steel components are hot-dip galvanised, and hence durable and practically maintenance-free;**

**the use of tubes with a 48.3 mm diameter permits combination and extension using traditional tube and coupler scaffolding at any time.**

**The function principle of Layher Allround scaffolding is unique.**

### Ingenious connection technology:

Safe, 1-man assembly at any height;  
sliding the wedge head over the rosette and inserting the wedge into the opening immediately secures the component...

...and a hammer blow on the wedge transforms the connection from structural assembly to high-strength force transmitting rigidity.

### Superior design:

Up to 8 connections can be made on one level – rosettes spaced every 0.5 m – to create the structurally ideal Allround joint.

### Built-in assembly speed:

4 narrow openings in the rosette automatically centre the ledgers at right angles – 4 wide openings permit the alignment of ledgers and diagonal braces at the required angles.

Assembly of the system is self-explanatory and is quickly learned.

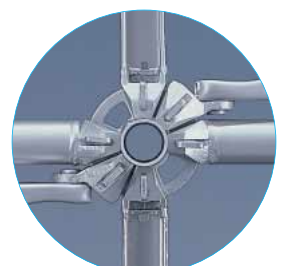
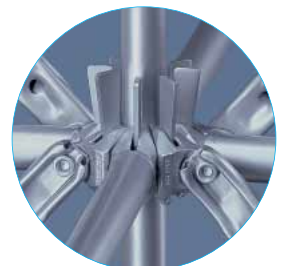

## The Layher product range at a glance:

- ▶ **AllroundScaffolding**  
Ingenious modular scaffolding
- ▶ **SpeedyScaf**  
Unbeatably fast frame scaffolding
- ▶ **Protective Systems**  
Modular roof and side cladding
- ▶ **Event Systems**  
Stands and stages, indoor and outdoor
- ▶ **Falsework**  
Support towers for high loads
- ▶ **Rolling Towers**  
Variety in height, size and access
- ▶ **Accessories**  
Highly flexible problem-solvers
- ▶ **Ladders**  
Uncompromising quality in aluminium and wood

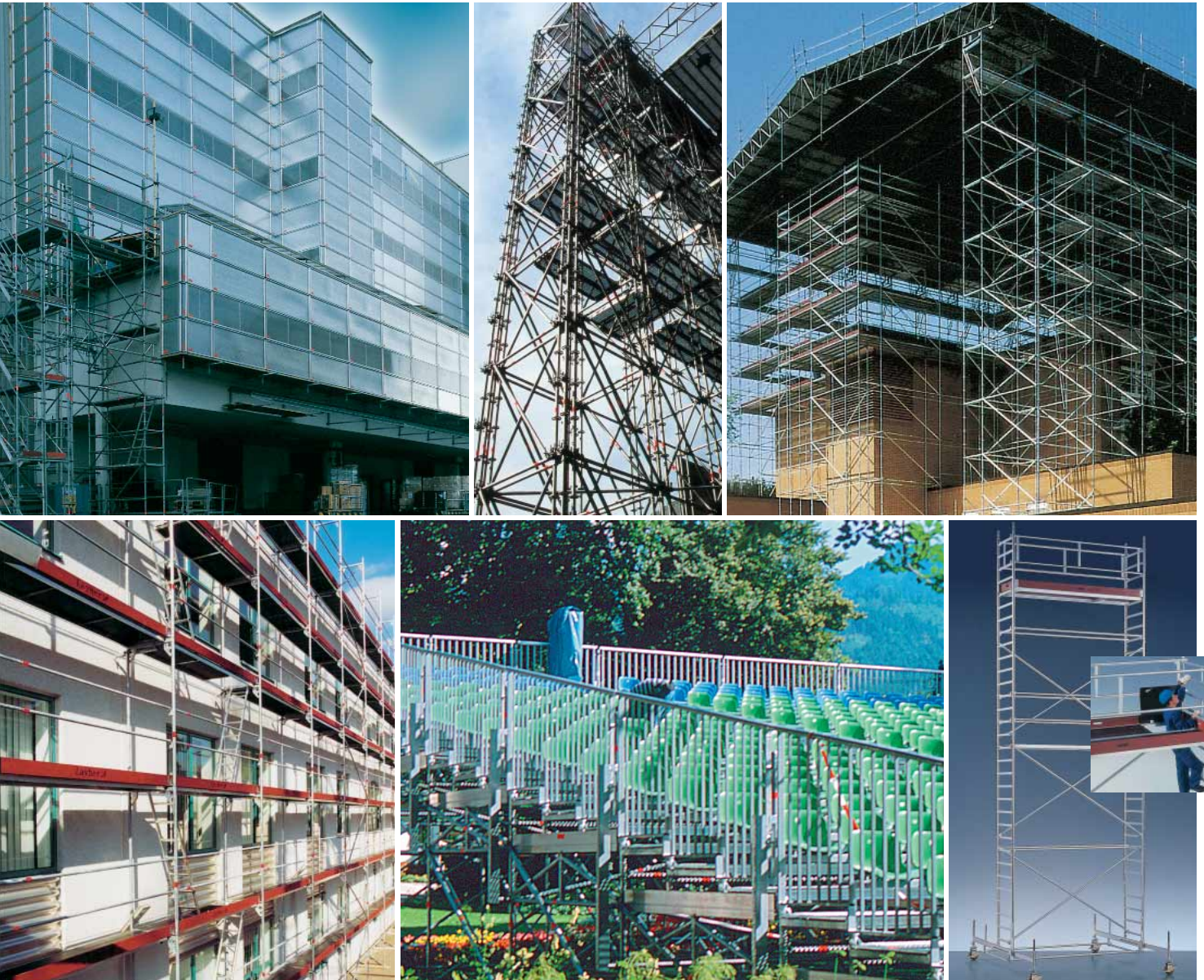

8116.204 Edition: 01-04-03.1

Wilhelm Layher GmbH & Co. KG

P. O. Box 40  
D-74361 Güglingen-Eibensbach

Phone: (\*\* 49) 71 35-7 00  
Fax: (\*\* 49) 71 35-7 03 72  
E-mail: [export@layher.com](mailto:export@layher.com)  
Web: [www.layher.com](http://www.layher.com)